

Conducted Emissions in DC Power Systems

Dr. Norbert Doerry, Dr. John V. Amy Jr.

Introduction

Electromagnetic compatibility requirements (EMC) for U.S. Navy shipboard equipment are defined in MIL-STD-461. First issued in 1967, this standard has evolved over time, with the latest version MIL-STD-461G issued in 2015. This standard groups EMC requirements into four categories: Conducted Emissions (CE), Conducted Susceptibility (CS), Radiated Emissions (RE), and Radiated Susceptibility (RS). An emission is created by Equipment under Test (EUT) while susceptibility is the ability of the EUT to function correctly when subjected to a specified electromagnetic environment (EME). The term “conducted” refers to electromagnetic effects that enter or leave the EUT on the conductors of electrical interfaces such as power leads, signal cables, or antenna ports. The term “radiated” refers to electromagnetic effects that enter or leave the EUT through the air.

This paper concentrates on the requirements for CE for shipboard direct current (DC) power systems that are derived from power electronics. MIL-STD-461 CE requirements only apply to equipment that are loads. The intent of the CE requirements is to work together with MIL-STD-1399-300 requirements to ensure the impact of CE on the power system does not result in other equipment exceeding CS requirements. A draft MIL-STD-1399-300 section is currently under development for Low Voltage DC (LVDC) (no greater than 1 kV) equipment. A draft MIL-STD-1390-300 section has also been developed for Medium Voltage DC (MVDC) equipment (6 kV, 12 kV, and 18 kV) (Doerry 2020). These new LVDC and MVDC sections are intended to support highly dynamic and pulsed loads. The questions then become: What are the implications of meeting these new interface standards and MIL-STD-461G CE requirements? Should the CE requirements be tailored or replaced for equipment employing the new LVDC and MVDC interface requirements?

Common mode (CM) circuits and differential mode (DM) circuits exist simultaneously for a given set of physical devices. While some of the conductive paths of these two circuits may be shared, others are not. The DM circuit is the intended circuit which motivates the selection of the particular set of physical devices. The existence of a somewhat different CM circuit is inescapable. These two circuits are not ‘orthogonal’, nor are they parallel/coincident; they may be coupled to varying

degrees. (Brovont and Lemmon (2017) and Brovont (2018)) Fundamental to analyzing both circuits is their relationship to a shared reference point, usually ground. The U.S. Navy’s approach to electric power system design has been to standardize the DM interface between the ships’ electric power systems and their client systems, then design and build those systems independently. The interface standards over the years have not explicitly mentioned the CM circuit. And, as indicated above, the client systems are the EUT to be tested for CE per the MIL-STD-461G. The development of new interface standards for LVDC and MVDC offers the opportunity to explicitly address CM currents. The question becomes how to specify limits on common mode currents in a meaningful way.

When shipboard electric power systems were dominated by electromechanical technologies employing three-phase 60 Hz ungrounded alternating current (AC) systems, the MIL-STD-1399-300 interface standard mitigated CM phenomena by ensuring relatively balanced three-phases, limiting capacitance-to-ground, and limiting energy injected by harmonics of 60Hz. 9kHz is the 150th harmonic of 60 Hz. MIL-STD-461G requirement CE101 is concerned with frequencies from 30Hz to 10kHz and measures DM and CM currents together. This is a very relevant range of frequencies for conducted emissions for three-phase 60Hz AC systems; however, the measurement of current in this frequency range skews the focus to DM circuits owing to the DM impedance and CM impedance frequency characteristics. MIL-STD-461G requirement CE102 is concerned with frequencies from 10kHz to 10MHz and measures voltages to ground at the measurement terminal of a Line Impedance Stabilization Network (LISN). The frequency characteristics of the LISN results in the CE102 measurements including substantial contributions from both CM and DM load currents. In many applications, the CM frequency content is primarily in the CE102 frequency range. Thus, CE101 measurements are generally dominated by DM ripple currents while the CE102 measurements are influenced by both the DM current and the CM current frequency content.

With the proliferation of switched power electronic converters (Variable Frequency Drives (VFD) for motors, power supplies for mission systems and habitability systems, 400 Hz. frequency changers, etc.), within three-phase 60Hz AC systems,

and especially in switched power electronic rectifier fed DC systems, the frequencies injected in the common mode and differential mode circuits include the intended frequency, perhaps 60Hz for an inverter or lower/higher for a motor drive, as well as the switching frequency of the switched power electronic converter and the harmonics of the switching frequency. (Brovont and Pekarek (2017)) This clearly shifts the frequency range of interest for both DM and CM currents from the lower order harmonics of 60Hz well into the megahertz range. Proliferation of wide-band-gap power electronics with switching frequencies on the order of a hundred kilohertz certainly pushes this into the 10MHz range, certainly into the lower end of the ShortWave2 band on your World Radio. (Lemmon et al. (2017)) The current realm and the voltage realm are no longer treatable separately; circuit design in the differential mode must consider common mode paths. As well, circuit features added to moderate common mode effects must consider differential mode paths.

The authors' work with Small Business Technology Transfer (STTR) N16A-T012 TITLE: Medium Voltage Direct Current (MVDC) Grounding System, which includes the work on two separate contracts, has as its objective, "Develop an affordable, general method for grounding Medium Voltage Direct Current (MVDC) zonal electrical power systems for naval warships." In this effort to establish a system ground interface, all of the issues mentioned thus far have come to the fore. Hence, for the practice of standardizing the interface between the ships' electric power systems and their client systems then designing and building those systems independently to continue, then the interface standard and the testing to verify compliance on both sides of the interface must explicitly consider both differential mode and common mode circuits over an expanded frequency range.

Line Impedance Stabilization Network (LISN)

Tests specified in MIL-STD-461G employ LISNs to provide a standard source impedance for the EUT. Figure 1 depicts the "standard" 50 μ H LISN specified in MIL-STD-461G. MIL-STD-461G states that an alternate 5 μ H LISN is appropriate where "high current loads exist (filter size may be massive to meet limit), where power distribution wiring has short lengths, or where dedicated returns run with the high sides (versus structure return). Since shipboard systems employ dedicated return runs and the other two conditions may also hold true, the criteria to use a 5 μ H LISN is met. Estimates of the DM inductance of four conductor cable for 12 kV MVDC range from 32 μ H per 1000 ft for high ampacity cable to 45 μ H per 1000 ft for low ampacity cable. If we assume an average cable length of about 333 ft, then a more optimally designed LISN

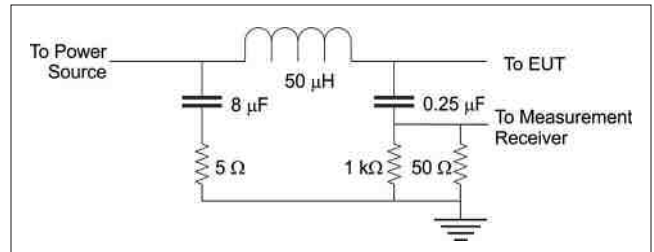

FIGURE 1. 50 μ H LISN schematic

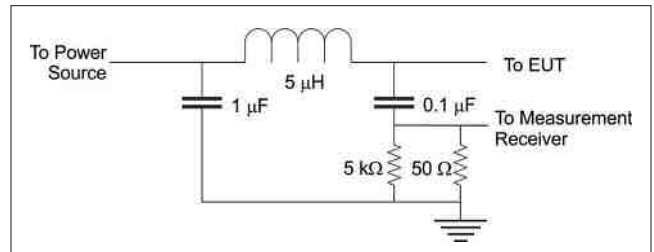

FIGURE 2. 5 μ H LISN schematic

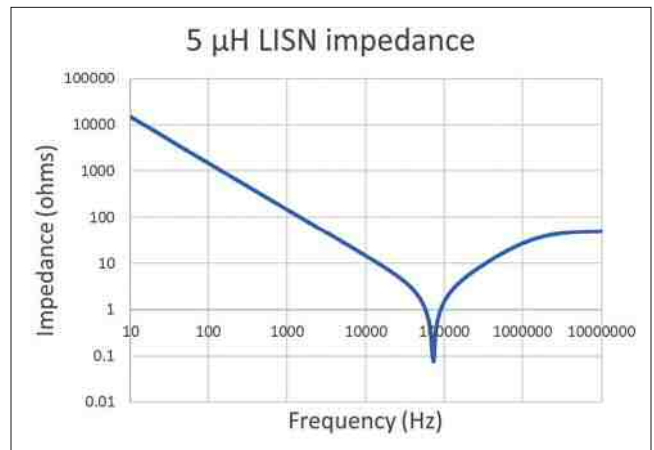

FIGURE 3. 5 μ H LISN impedance from EUT to ground (Input open)

would have an inductance between 10 and 15 μ H. Since these values are closer to 5 μ H than 50 μ H, the use of a 5 μ H LISN is warranted. Figure 3 depicts the impedance of the 5 μ H as measured from the EUT port to ground with the terminal to the power source open.

CE101 Requirement

The MIL-STD-461G CE101 Requirement is based on the use of two LISNs as depicted in figure 4. The current probe is used to measure the ripple current into the EUT over a frequency range of 30 Hz to 10 kHz. This ripple current is a combination of differential mode and common mode currents. The differential mode current interacts with the differential mode impedance depicted in Figure 5 to produce a ripple voltage at the

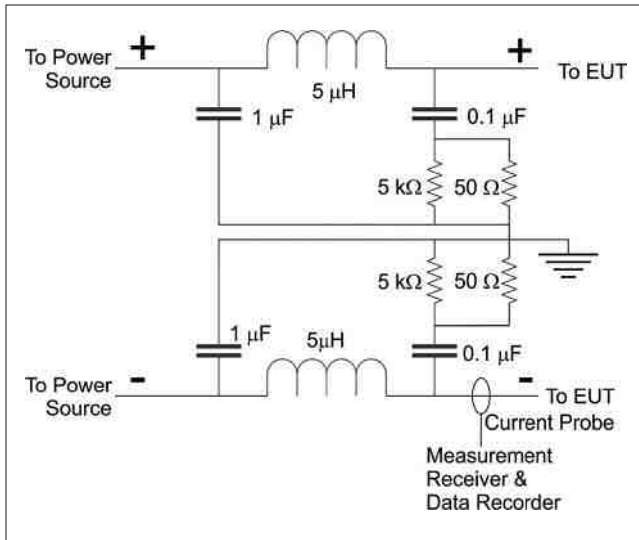

FIGURE 4. CE101 configuration with 5 μH LISNs

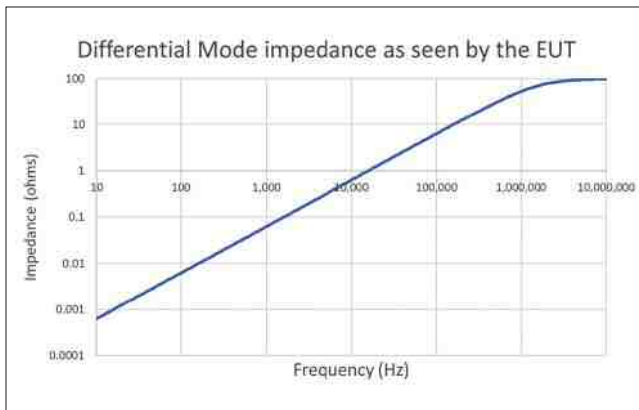

FIGURE 5. Differential Mode impedance of CE101 configuration as seen from EUT

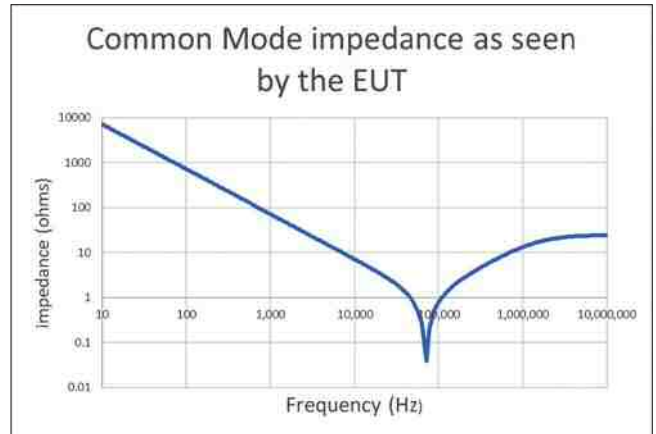

FIGURE 6. Common Mode impedance of CE101 configuration as seen from EUT

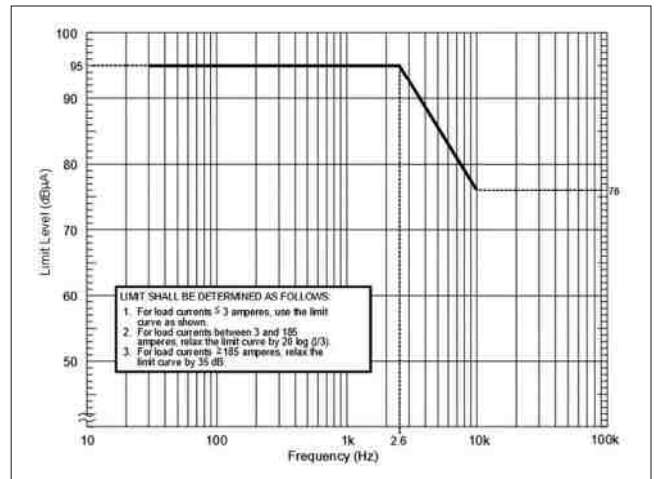

FIGURE 7. MIL-STD-461G CE101 limit for surface ships and submarine applications, DC.

terminals of the EUT. At low frequencies, the differential mode impedance is very low, so the impact of the differential mode current on the voltage ripple is low. At 10 kHz however, the impedance is about 0.63 ohms, which can result in a moderate differential mode voltage ripple at the EUT for higher ripple currents at this frequency. Conversely, as depicted in figure 5, the common mode impedance as seen by the EUT is high at low frequencies, and reduces in magnitude at 10 kHz. Consequently, the current measurement at low frequencies is likely to be mostly differential mode current. At frequencies approaching 10 kHz however, the current measurement may have a significant contribution of common mode current.

Figure 7 depicts the CE101 requirement. The 95 dB μA limit at lower frequencies for loads less than 3 amps translates to 56.2 mA. For loads between 3 and 185 amps, the requirement is a constant percentage equal to the limit at 3 amps, or 1.87%.

For any load above 185 amps, the limit at lower frequencies is 3.16 amps. The standard does not explain why a hard limit was placed on loads above 185 amps instead of continuing with the constant percentage. The reduction in the limit above 2.6 kHz has the effect of limiting the impact of the increasing differential mode impedance on the differential mode voltage ripple seen by the EUT.

CE102 Test

The CE102 test places limits on conducted emissions between 10 kHz and 10 MHz. The same LISNs from the CE101 test are used, but the measurement is a voltage to ground taken at one of the 50 ohm termination as depicted in Figure 8. The CE102 limits are depicted in Figure 9. Note that the maximum voltage listed is 440 volts which is less than most of the proposed LVDC and MVDC standard voltages.

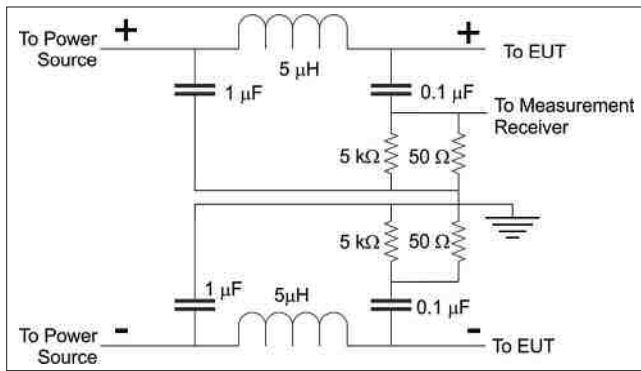

FIGURE 8. CE-102 configuration with 5 μH LISNs

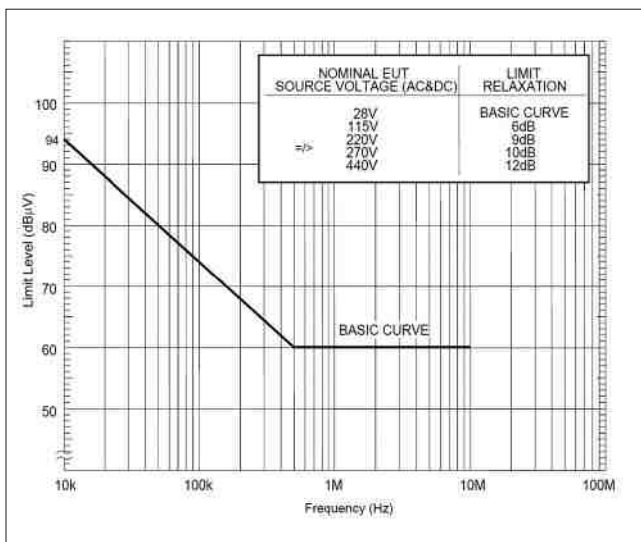

FIGURE 9. MIL-STD-461G CE102 limit for all applications

The input impedance of the two LISNs as viewed from the source and with no EUT is depicted in figure 10 for DM and figure 11 for CM. The voltage gain from the input to the measurement receiver is also plotted in figure 10. Note that this voltage is between 0.1 and 1 over most of the frequency band. This implies that the source should have a very low voltage ripple to ensure the voltage at the measurement receiver is not distorted by the source voltage ripple. Figure 11 also shows the trans-impedance which is the voltage at the measurement receiver divided by the CM current from the source. Based on this characteristic and to minimize source impact on the voltage at the measurement receiver, the source should be designed to have very low CM currents.

Figures 12 and 13 depict the DM and CM impedance and transimpedance of the two LISNs as measured at the terminals of the EUT with the input shorted. The transimpedance is the ratio of the voltage at the measurement receiver divided by the load current (either DM or CM). In comparing the

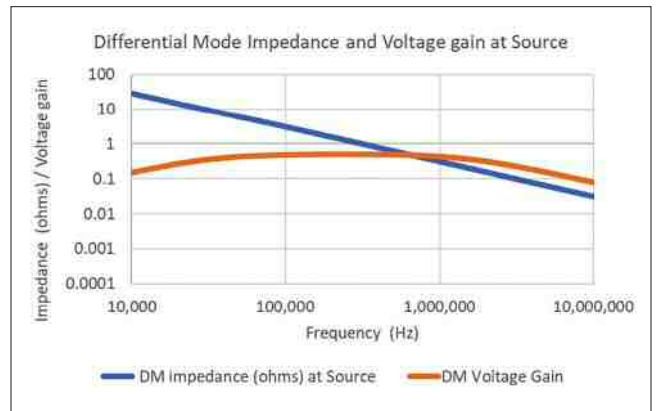

FIGURE 10. DM Impedance and voltage gain at the source for CE102 test (no EUT)

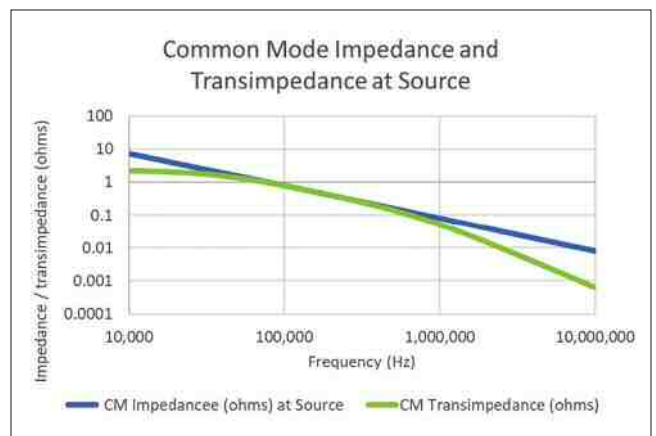

FIGURE 11. CM impedance and transimpedance at the Source for CE102 test (no EUT)

transimpedance plots, the voltage at the measurement receiver is more sensitive to DM ripple current than it is to CM current over most of the frequency range.

Applicability of CE101 and CE102 to DC power distribution systems.

MIL-STD-461G indicates that the CE101 requirements are meant to limit the harmonic line currents for each electric load in the power system. This implies that CE101 is intended to apply primarily to DM currents and is consistent with the findings of the previous section. If compatibility of loads and sources with respect to differential mode ripple frequency for DC systems is properly addressed in the new MIL-STD-1399-300 sections for DC interfaces, then the need to apply CE101 to DC load equipment is eliminated. The existing fixed limit for loads above 185 amps is not realistic for high power systems where the load current could be an order of magnitude larger than 185 amps. The reason for this fixed limit

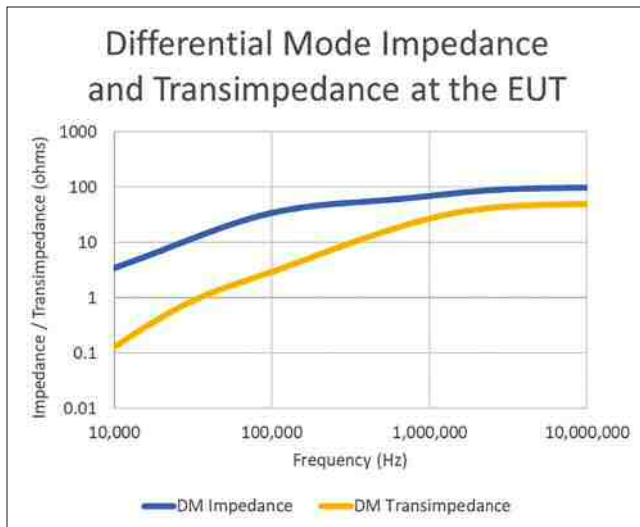

FIGURE 12. Differential Mode Impedance and Transimpedance at the EUT

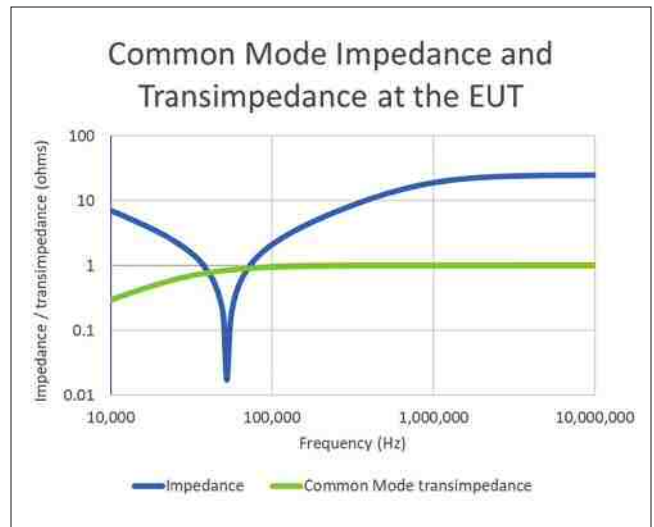

FIGURE 13. Common Mode Impedance and Transimpedance at the EUT

is also not explained within the standard. Furthermore, the existing LISN design is not intended for MVDC applications with megawatt class loads; a different type of LISN is likely required for MVDC.

Similarly, the CE102 limits at the lower frequencies are also intended to facilitate interoperability of sources and loads at the lower frequencies. At higher frequencies, the intent is to avoid power line radiated emissions from exceeding radiated emissions (RE102) limits. Furthermore, the limits associated with CE102 are fixed values for any voltage above 440V (AC or DC) and is not realistic for high power systems with voltages much greater than 440 V and with high load currents.

While CE101 and CE102 limits are not ideal for high power DC power systems, the rationale for the CE102 limits not resulting in excessive radiated emission has merit. Radiated emissions of CM currents differ significantly from radiated emissions of DM currents. It makes sense to measure and limit CM currents and DM independently so that radiated emissions are limited. Interoperability of sources and loads can be accomplished via well written MIL-STD-1399 section 300 interface standards.

MVDC CM and DM current limits based on RE101 Test

The RE101 test is applicable to frequencies between 30 Hz and 100 kHz and places limits on magnetic field radiated emissions as measured in picoteslas at a distance of 7 cm from the equipment. These limits are shown in Figure 14. Conducted emissions can be related to radiated emissions by calculating the field caused by currents of a given frequency

within the conductors of cables. MVDC cables are anticipated to be configured as quad cables as shown in Figure 15. (Doerry and Amy (2018)) The magnetic field depends on the angle measured from the positive x-axis of Figure 15, centered at the middle of the cable. As shown in Figure 16, the DM field peaks in the direction of the diagonals (45 degrees) and is zero perpendicular to a face. The exact shape of the curve depends on the distance of the measuring point from the cable. This characteristic is not surprising because perpendicular to a face, the fields from the positive and negative conductors cancel each other. Similarly, since the field is proportional to the inverse of the distance from conductor to measuring point, at 45 degrees, the distance of the measuring point from the nearest conductor is a minimum, thus the field is a maximum.

To limit the influence of CM currents on the magnetic fields, MVDC quad cables are anticipated to have an overall cable shield around all four conductors. This cable shield is grounded at both ends to provide a return path for the CM current through the four conductors. The fields from CM currents depend on the effectiveness of the shield which is measured as a fraction of the CM current in the four conductors that returns in the shield. A perfect shield (with a shield effectiveness of 1.0) can reduce the maximum field by about a factor of over 100 as compared to no shield (shield effectiveness of 0). The exact ratio depends on cable configuration. As shown in figures 17 and 18, the CM fields are maximized at an angle of 45 degrees. The difference between the maximum and minimum fields are proportionally much less than for the DM; with no shield, the field is almost independent of angle.

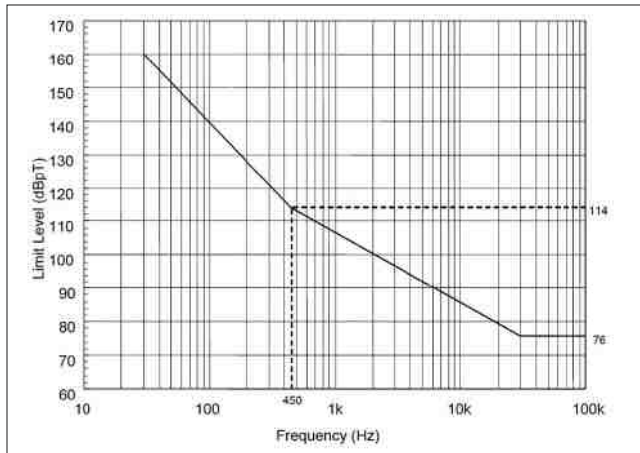

FIGURE 14. MIL-STD-461G RE101 limit for all Navy Applications

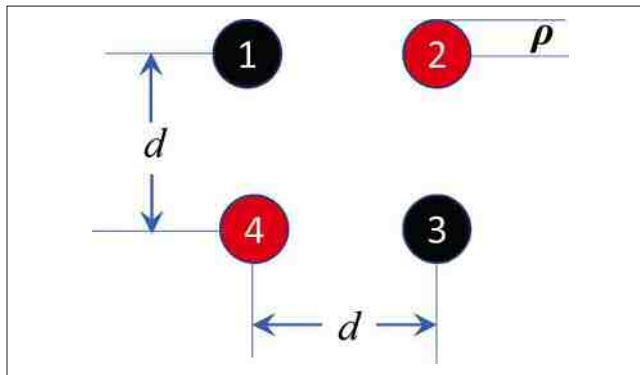

FIGURE 15. Quad Conductor Cable configuration

In addition to the properties of a single cable, the field from a bundle of cables (figure 19) depends on the geometry of the bundle, as well as the angle of rotation of each of the cables. The strategy for developing the ripple frequency requirements on the DM and CM currents is based on the following:

- a. The frequency content of the CM and DM currents are independent of each other ... hence the limits can be developed independently of each other.
- b. The DM limits are based on the maximum possible field generated by a specific bundle of cables being equal to the RE101 limits. (Sensor being 7 cm from the cable bundle) The DM limit is expressed as a fraction of rated current / ampacity measured in dB. This bundle is a ten cable bundle using a notional 12 kV DC cable with one diameter between cables and nine inches between two banks of five cables. Each cable has an anticipated ampacity of 458 amps, or a total of 4580 amps for the cable bank. This is expected to be on the order of the maximum capacity that would be

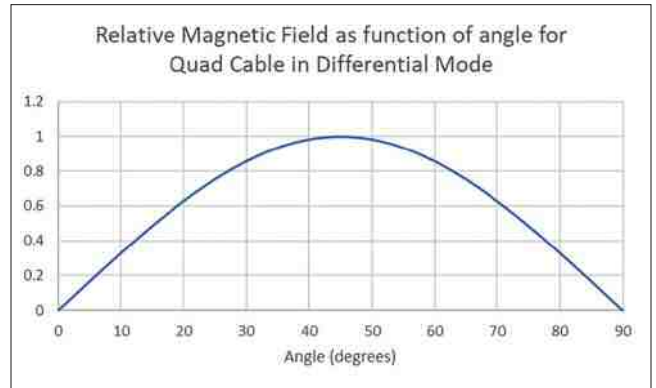

FIGURE 16. Relative Field Strength as a function of angle for DM

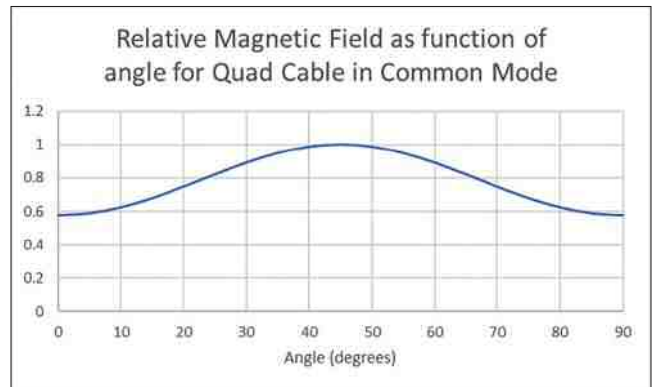

FIGURE 17. Relative Field Strength as a function of angle for CM with shield

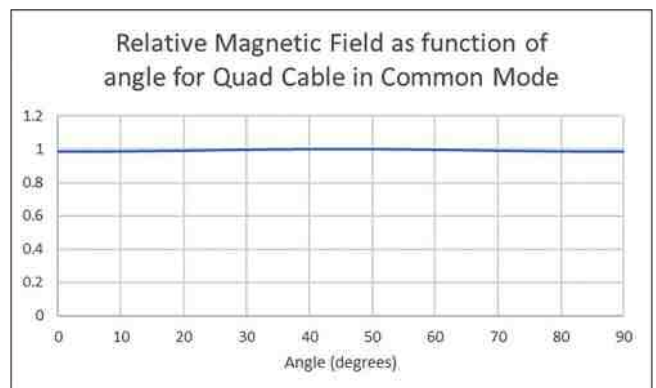

FIGURE 18. Relative Field Strength as a function of angle for CM without shield

installed on a naval combatant. The difference in field (as measured in dB) between a single cable and a ten-cable bundle is estimated to be on the order of 2 db. While the maximum possible field is likely much higher than will be realized in practice (The cables will likely have a random

rotational angle) the use of the maximum possible field serves as a margin for the actual bundle and cable configuration being different from the assumed bundle and cable.

- c. The total frequency content of the DM ripple current should not exceed 10% of rated current. Hence the frequency content of the ripple current of a single frequency should also not exceed 10% of rated current – even if more would be allowed by RE101 limits
- d. The CM limit is based on the field generated by a single cable being equal to the RE101 limits. The common mode limit is expressed in terms of dB ref μA . The CM current is divided among all the conductors in a bundle, hence the current through any one conductor is less than for a single conductor. For this reason, the field from the CM current in a single cable will be greater than for bundle of more cables.
- e. A shield effectiveness of 0.9 is assumed for the CM limit. This value is arbitrary and should be adjusted based on further analysis.
- f. The CM current should have a magnitude of less than 1 amp under normal operating conditions – even if more would be allowed by RE101 limits. This value is arbitrary and should be adjusted based on further analysis. (If the CM current is greater than 15 mA, a safety risk exists when disconnecting cable from equipment since CM current can flow through the cable even if the DM current has been isolated via a switch. In this case a means should be provided to interrupt the CM current)
- g. The worst-case field for both the CM and DM cases is obtained by rotating each cable such that its diagonal (angle of

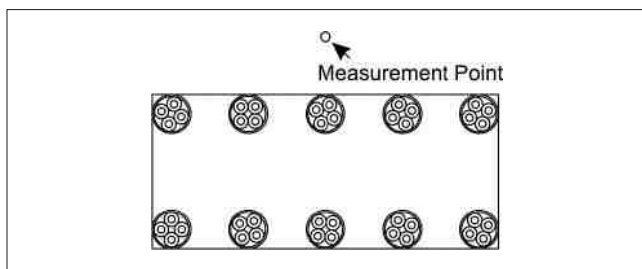

FIGURE 19. Cable Bundle

45 degrees) points to the measurement point.

For a long conductor or cylinder, the magnetic field B measured in teslas at a radial distance r (meters) from the conductor or cylinder center caused by a current I (amps) is given by ...

$$B = \frac{\mu_0 I}{2\pi r}$$

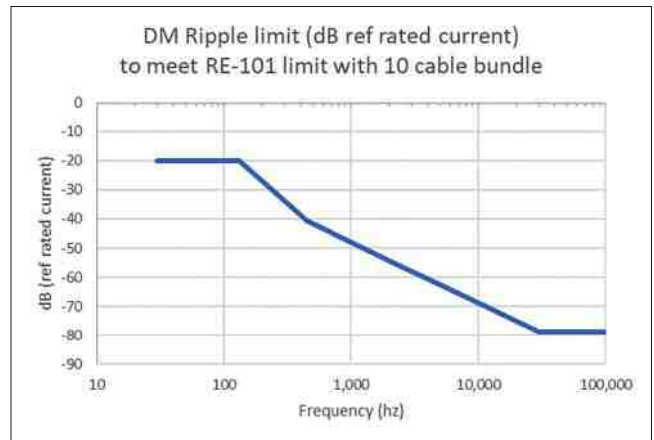

FIGURE 20. DM Ripple limit to meet RE101 requirements

Where μ_0 is the permeability of free space: $\mu_0 = 4\pi \times 10^{-7} \frac{N}{A^2}$ or $\frac{H}{m}$.

Since the field is proportional to current, we can calculate the field for a given current and easily adjust for a different current.

Calculations for a ten cable bundle show a maximum field of 5.459×10^6 picoTeslas (pT) when all cables are carrying DC current at their rated ampacity (458 amps each) and the DM ripple current is limited to 10% of the DC current. This field level corresponds to 134.7 dB.

Examining figure 14, the RE101 limit at 132.7 Hz matches 134.7 dB. Hence, below 132.7 Hz, limiting the ripple current to below 10% of rated current will automatically result in the RE101 limits being met. Figure 20 depicts the maximum ripple allowable while still meeting the RE101 limits.

Figure 21 limits applied to a 3 amp load then expressed in terms of dB ref μA is presented in Figure 14, as well as the corresponding CE101 limits. For loads up to 185 amps, both curves would be relaxed by the same amount, preserving the relative difference between the two graphs. Above 185 amps, the CE101 limit would remain constant while the RE101 derived limit would continue to be relaxed. This suggests that the CE101 limit can be raised at lower frequencies without resulting in excessive radiated emissions from the cables. Conversely, lowering the limit at higher frequencies should be considered. Another possibility is to develop the requirement based on RE more than 7 cm from the cables. For example, if the measurement distance is increased to 12 inches, the RE-101 derived limit depicted in figure 20 would increase by 26.7 dB (ref rated current) up to a maximum of -20 dB. This would also raise the RE-101 derived curve in Figure 21 by 26.7 dB (up to a maximum of 109.5 dB) which would place it above the CE-101 curve. Design practices would then be needed to

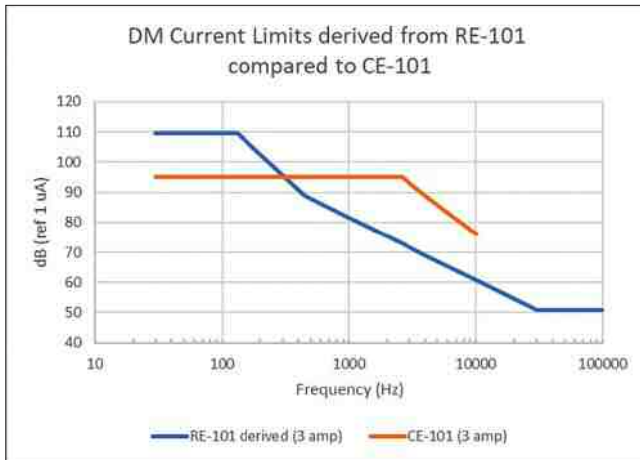

FIGURE 21. Comparison of RE101 derived DM limits to CE101 limits

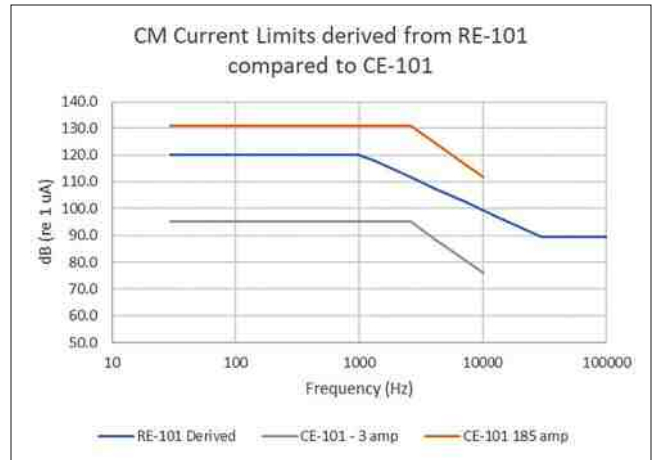

FIGURE 22. Comparison of RE101 derived CM limits to CE101 limits

avoid placing susceptible equipment within 12 inches of the cable bank.

The field due to CM current is highly impacted by the shield effectiveness. As shown in Table 1 for a representative MVDC cable, a shield can attenuate the radiated field by over 40 dB. The difference between a shield effectiveness of 0.90 and 1.0 is over 23 dB. For this analysis, a shield effectiveness of 0.90 will be used, but further research is needed to identify a more representative value.

Since the CM current should be less than 1 A (by assumption), the maximum limit should be 120 dB ref 1 μ A independent of the limit derived from RE101. Figure 22 presents the CM limits derived from the RE101 limits and compares them to the CE101 limits for a 3 amp load and a 185 amp load. For loads greater than 185 amps, the CE101 limit is relaxed by 35.8 dB and the CE101 curve is above the curve derived from RE101. Hence at low current levels, the RE101 derived limit is less conservative than CE101. Conversely, the RE101 limit is more conservative at higher current levels.

Shield Effectiveness	Magnetic Field DB ref 1 pT from 1 Amp CM current
0.0	126.0
0.9	106.5
1.0	82.8

TABLE 1. Magnetic Field from a representative MVDC cable CM current

Recommendations and Future Work

Based on the work presented, we recommend the following:

1. For DC applications above 440 volts, use RE-101 derived limits for CE similar to those depicted in figure 20 for DM

currents and figure 22 for CM currents. DM current limits should be specified in terms of dB ref rated current while CM current limits should be expressed dB ref 1 μ A.

2. New LISNs should be developed that are appropriate for DC applications above 440 volts. These LISNs should isolate measured CM and DM currents from the source. The CM measurements should be measured via a functional CM short to ground for frequencies of interest. As seen from the EUT, the CM impedance through the point of CM current measurement should be several orders of magnitude less than the CM impedance through the power cable to the source.
3. The assumptions used to create figures 20 and 22 should be examined in detail, adjusted as necessary, and used to update figures 20 and 22.
4. The MIL-STD-1399 section 300 parts being developed for LVDC and MVDC should be written to ensure compatibility between sources and loads with respect to DM currents and voltages.
5. The RE-101 derived CM and DM limits, and LISN designs, should be codified in the MIL-STD-1399 section 300 parts being developed for LVDC and MVDC.
6. The shielding requirements for LVDC and MVDC cable should be codified in applicable technical documents to ensure the required CM shield effectiveness is achieved.

We also recommend the following future work:

1. Write a standard to detail the test procedures for using the new LISNs to measure CM and DM currents in order to determine if the EUT meets RE-101 CE requirements for both CM and DM currents.
2. Develop a method for establishing CM and DM limits for

frequencies above the range covered by RE-101. This method should be effective at a minimum over the range of 100 khz to 10 Mhz.

3. Because the cables for loads with rated currents in the 10's of amps or lower may not be quad cables assumed in this paper, explore what the CM and DM limits should be for these loads.
4. Co-axial insulated bus pipe (IBP) may be employed to eliminate the need to parallel many cables in high power applications. As with cable, the CM shield effectiveness will have a major influence on RE and should be studied in greater detail. Because of field cancellation due to the co-axial conductors, the RE from DM currents should be minimal for straight runs of co-axial IBP. The RE from DM and CM currents should be studied where the geometry is not a straight run.
5. Study the impact of CE limits on system stability. Determine if sufficient stability methods exist to affordably achieving system stability with the proposed RE-101 derived CE limits. If not, determine appropriate CE limits based on stability concerns.

Conclusions

This paper has analyzed existing MIL-STD-461 CE requirements and noted their shortcomings for modern MVDC and LVDC applications. A process has been proposed to develop CM and DM requirements for frequencies between 30 Hz and 100 kHz based on RE101 requirements. Results of this process with stated assumptions are compared to existing requirements. Future work to refine this method and incorporate it into specifications and standards has also been identified. **NEE**

AUTHOR BIOGRAPHIES

DR. NORBERT DOERRY is an engineer working for the Naval Surface Warfare Center Carderock Division, Code 823, Ship and Submarine Design Software Branch.

DR. JOHN AMY JR. P.E. is the Senior Technologist for Naval Power Architectures Technologies at the Naval Surface Warfare Center Philadelphia, PA, USA.

REFERENCES

- Brovont, A. D. and A.N. Lemmon, (2017) "Common-Mode/Differential-Mode Interactions in Asymmetric Converter Structures," ESTS 2017, pp. 84-90, Aug. 2017. (<https://ieeexplore.ieee.org/document/8069264>)
- Brovont, A.D. and S.D. Pekarek, (2017) "Impact of Switching Frequency and Edge Rates on Common-Mode Current in MVDC Microgrids," ESTS 2017, pp. 16-24, Aug 2017. (<https://ieeexplore.ieee.org/document/8069254>)
- Brovont, Aaron D., (2018) "Generalized Differential-Common-Mode Decomposition for Modeling Conducted Emissions in Asymmetric Power Electronic Systems," IEEE Transactions on Power Electronics, Vol 33, Issue 8, Aug 2018. (<https://ieeexplore.ieee.org/document/8253898>)
- Doerry, Norbert (2020) "Preliminary Interface Standard, Medium Voltage Electric Power, Direct Current," Naval Sea Systems Command, Technology Office (SEA 05T), Ser 05T / 002 of 16 January 2020. (<https://apps.dtic.mil/sti/citations/AD1090170>)
- Doerry, N. and J. Amy Jr., (2018) "MVDC Distribution Systems," presented at ASNE AMTS 2018, Philadelphia PA, March 28-29, 2018. (<http://www.navalengineers.org/Resources/Product-Info/productcd/AMTS2018-Proceedings>)
- Lemmon, A., R. Cuzner, J. Gafford, R. Hosseini, A.D. Brovont, and M. Mazzola, (2017) "Methodology for characterization of common-mode conducted electromagnetic emissions in wide-band-gap converters for ungrounded shipboard applications," IEEE J. Emerg. Sel. Topics Power Electron., vol. PP. no. 99, pp. 1-1, 2017. (<https://ieeexplore.ieee.org/document/7962156>)
- Pierce, James DSS. Jr., (2009) "Electromagnetic Compatibility (EMC) Requirements for Military and Commercial Equipment," Naval Postgraduate School, Monterey, CA, September 2009. (available from <https://apps.dtic.mil/dtic/tr/fulltext/u2/a509335.pdf>)
- Satav, Sandeep M. and VV Rama Sarma, (2008) "MIL-STD-461 F - A Study Report," INCCEM 2008: 10th International Conference on Electromagnetic Interference and Compatibility, Proceedings. (available from https://www.researchgate.net/publication/261470751_MIL-STD-461_F_-_A_study_report)